

# ARGOS

*Drive thru*

**HI-TECH  
RECEPTION  
LANE**











**CEMB**



# FULL ALIGNMENT C

- Place **ARGOS DRIVETHRU** in the reception lane of your shop; it is adaptable to any work environment
- Increase **customers' satisfaction** levels by offering a fast, complete and highly professional service
- Offer your customers maximum transparency with **clear and immediately understandable diagnostic reports**
- **Increase your turnover** by checking all incoming vehicles in a few seconds and identifying those that show anomalies and need adjustments
- **Eliminate efforts** thanks to fully automated procedures with consequent time savings

		Vehicles checked	Needing adjustment	Adjustments sold	Profit
60  Vehicles / week	TRADITIONAL inspection	 20%	 6	 3	
	<b>ARGOS</b> <i>DriveThru</i> inspection	 100%	 30	 15	

# ARGOS

*Drive thru*

SAVE TIME WITH NON-CONTACT MEASUREMENTS!



## CHECK IN SECONDS

- **Identification of full alignment**, including partial Toe and steering wheel centering
- **Autonomous control of the alignment** that can be performed directly by the customer by following simple steps shown on the screen
- **Non-contact measurement**: no more clamps, targets or sensors for effective time savings and no risk of damaging the rims
- **Diagnosis of vehicle anomalies** and indication of possible related symptoms (fuel consumption, tyre wear, driving and steering anomalies)
- **Automatic selection of vehicle specifications** via license plate recognition (optional)\* or Fast specs search
- **Real-time specs**: vehicle specifications database updated in real time
- **Remote control app** for tablets and smartphones
- 4 different **customizable** graphic layouts

OPTIONAL

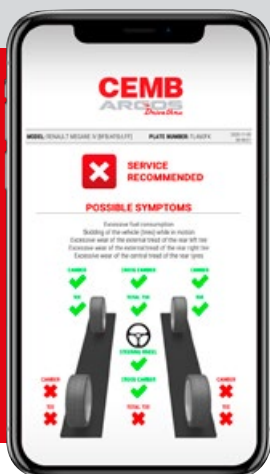

Send real-time results to your customers directly via smartphone and tablet



or provide printed report

- 50" monitor with wall mount
- 27" monitor with support column
- Wifi printer
- New vehicle licence plate recognition: the camera, integrated in the Argos Drivethru columns, recognises the vehicle's licence plate from the first moment it enters the workshop and automatically calls up its specifications\*
- Known vehicle license plate recognition: the integrated camera recognises the vehicle's license plate by automatically recalling the previously selected specifications. The vehicle specifications must be selected manually on first access\*

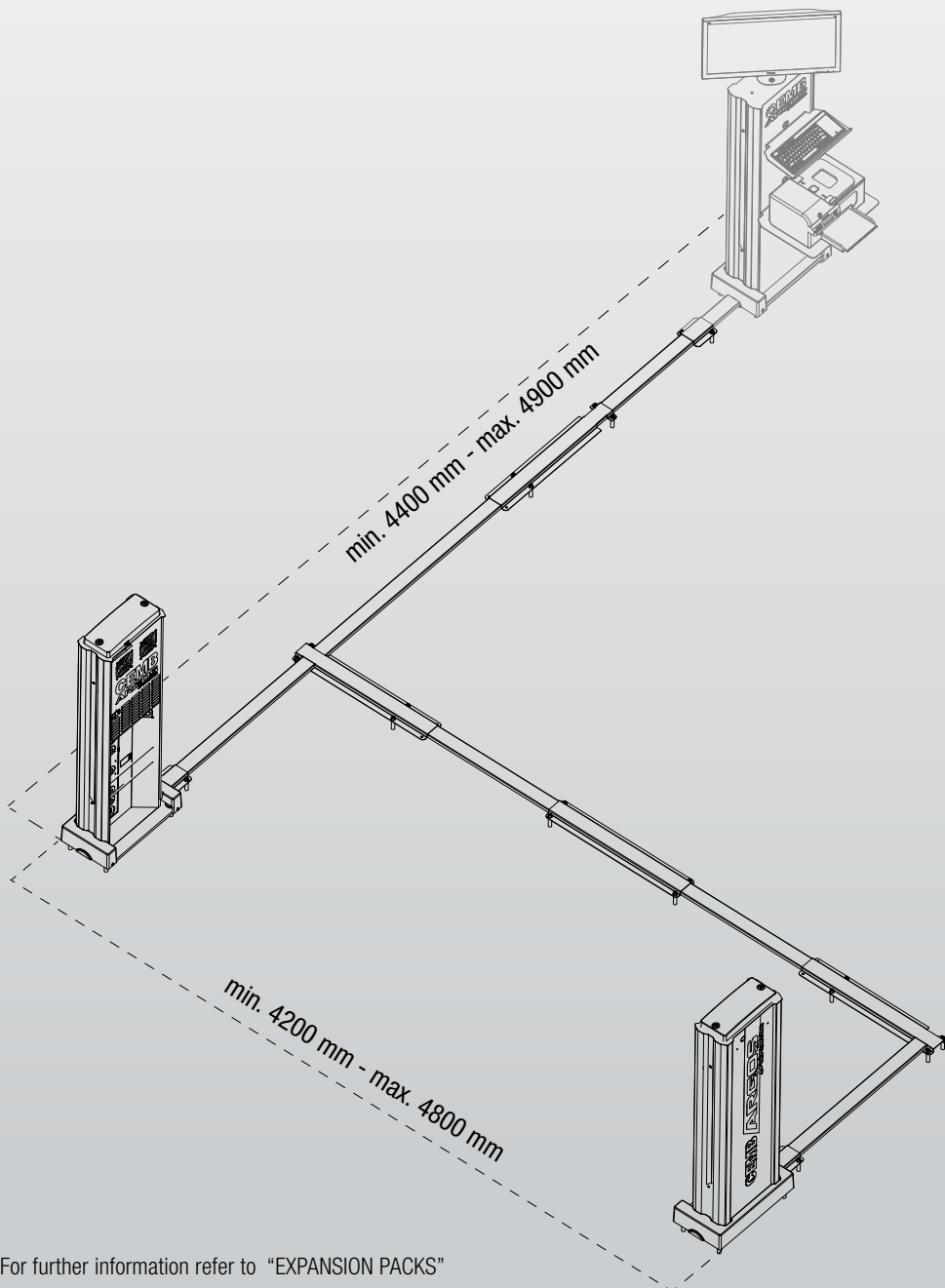

# CEMB

**CEMB S.p.A.**  
Via Risorgimento, 9  
23826 Mandello del Lario (LC) Italy  
[www.cemb.com](http://www.cemb.com)



**Garage equipment division**  
**CEMB - ITALY**  
**Plant and Training Center**  
phone +39 0341 706111  
[garage@cemb.com](mailto:garage@cemb.com)