

VIBRATION AND AXIAL DISPLACEMENT TRANSMITTER

TR-NC/8

The TR-NC/8 transmitter measures the relative vibration or the axial displacement of a shaft and it is able to interface directly in 2 wires technique (current loop $4 \div 20$ mA) to an acquisition system (PLC or DCS).

The measuring chain is composed by a proximity sensor, an extension cable and a transmitter. It is supplied complete with:

- No. 4 contacts: two for the 24 Vdc connection of the power supply and two for the check of the voltage gap for the probe positioning
- BNC socket for the connection to a portable analyser
- Coaxial connector for the sensor connection

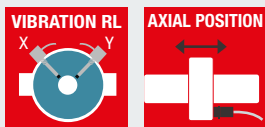

TECHNICAL CHARACTERISTICS

Composition	<ul style="list-style-type: none"> ■ ST-NC/8 sensor ■ Extension cable ■ TR-NC/8 transmitter
Power supply	<ul style="list-style-type: none"> ■ 24 Vdc ($18 \div 32$ Vdc) current loop $4 \div 20$ mA (2 wires) ■ Maximum load see figure 1
External connection	<ul style="list-style-type: none"> ■ Bipolar shielded cable to the terminals POWER +/-
Environmental field	<ul style="list-style-type: none"> ■ Sensor: -55°C to 180°C (ATEX: -55°C to 175°C) ■ Extension cable: -55°C to 180°C (ATEX: -55°C to 175°C) ■ Transmitter: -40°C to 80°C (ATEX: -20°C to 70°C)
Measurement type	<ul style="list-style-type: none"> ■ Relative vibration ■ Axial displacement
Dynamic field	<ul style="list-style-type: none"> ■ 1.5÷10.000 Hz (vibration) ■ 0÷500 Hz (displacement)
Linearity	<ul style="list-style-type: none"> ■ $\pm 2\%$ (range $0,5 \div 2,5$mm; T=100°C)
Insulation	<ul style="list-style-type: none"> ■ $\geq 10^8 \Omega$ between signal and container
Possible arrangements to the order	<ul style="list-style-type: none"> ■ Measurement type (vibration, axial displacement) ■ Cable length ■ Measuring range ■ Type of target ■ Type of certification

TR-NC/8 TRANSMITTER

The transmitter is also available as ATEX certified for classified area application

Ex II 1G Ex ia IIC T6,T5 Ga (ATEX)
Ex ia IIC T6,T5 Ga (IECEX)



Power supply:	24Vdc
Target:	AISI 4140 (default) Any Steel (optional)
Dynamic field:	1,5 ÷ 10KHz vibration 0 ÷ 500Hz displacement
Environmental field:	-20°C ÷ +70°C
DIN Rail:	Yes

Maximum load on current loop

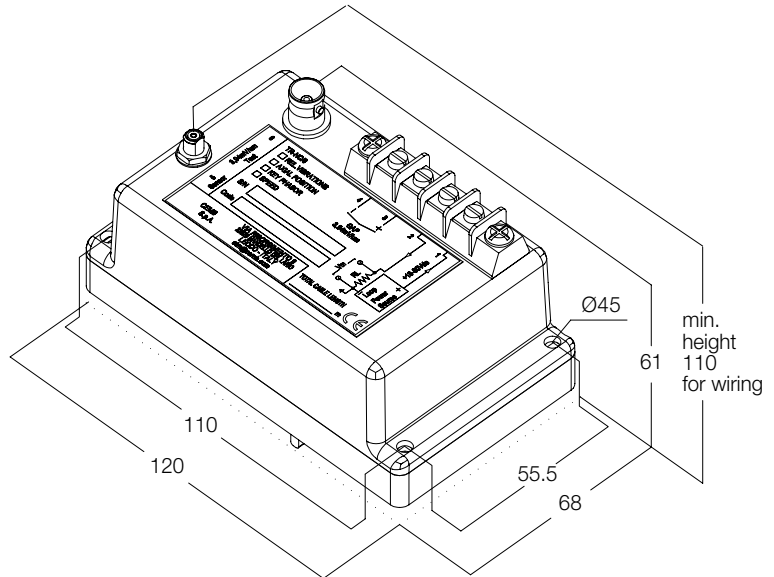
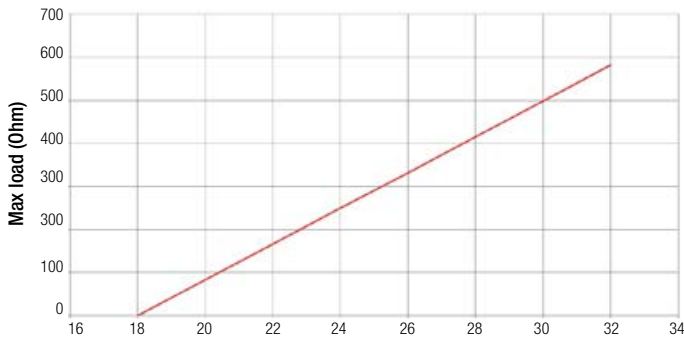

CONVERTER

TR-NC/ 8 / / / / /

A: MEASUREMENT TYPE

1	relative vibration
2	axial displacement

B: CABLE TOTAL LENGHT

1	5 m
2	7 m
3	9 m
S	special

C: MEASURING RANGE

01	0÷100 µm vibration
02	0÷125 µm vibration
03	0÷200 µm vibration
04	0÷250 µm vibration
05	± 0,5 mm axial displacement
06	± 0,75 mm axial displacement
07	± 1 mm axial displacement
SP	special

D: TYPE OF TARGET

1	AISI 4140
2	AISI 410
3	AISI 304
4	AISI 630
5	C45
6	INCOLOY
7	ER7T-ER8
S	special

E: TYPE OF CERTIFICATION

1	Standard
2	Ex II 1G Ex ia IIC T6,T5 Ga (ATEX)
3	Ex ia IIC T6,T5 Ga (IECEX)

INTEGRATED CABLE TYPES

Not armoured

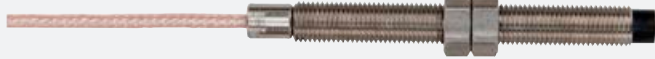

Armoured



Material:	Stainless steel
Thread:	M10 o 3/8" - UNF
Body:	40 mm ÷ 250 mm
Oil proof:	Yes
Stainless steel armour cable:	Optional

EXTENSION CABLE (optional)

Not armoured



Armoured



Stainless steel armour cable: Optional

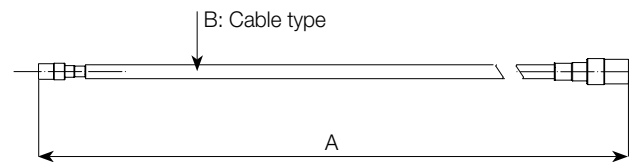
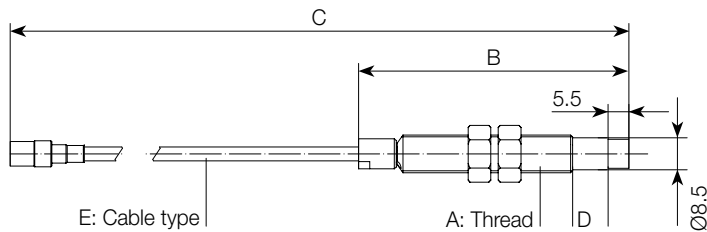

PROBE

ST - NC / 8 / / / / /

A: THREAD TYPE

0	M10x1
1	3/8"-24UNF
S	special

B: BODY LENGHT

pitch 10 mm – minimum 40 mm (4) – maximum 250 mm (25)

5	50 mm (standard)
---	------------------

C: TOTAL SENSOR LENGTH (BODY + CABLE)

pitch 500 mm – minimum 500 mm (5) – maximum 9000 mm (90)

10	1000 mm (standard)
----	--------------------

D: UNTHREADED PART LENGTH (ONLY FOR M10X1)

pitch 10 mm – Minimum 0 mm (0) – Maximum 120 mm (12)

0	0 mm (standard)
---	-----------------

E: CABLE ARMATURE

0	not armoured
1	armoured

EXTENSION CABLE (optional)

CPT - NC / 8 / /

A: CABLE LENGHT

pitch 500 mm – minimum 1500 mm (15) – maximum 8500 mm (85)

40	4000 mm (standard)
----	--------------------

B: CABLE ARMOUR

0	not armoured
1	armoured

* In the old coding, number zero "0" could be present before the code number.

Example:
ST-NC/8/0/05/010/00/0 (old code)
Equivalent to:
ST-NC/8/0/5/10/0/0 (new code)

CEMB

SR-6

Probe Adapter allowing the installation on the rotor and easy setting of the probe on the field.

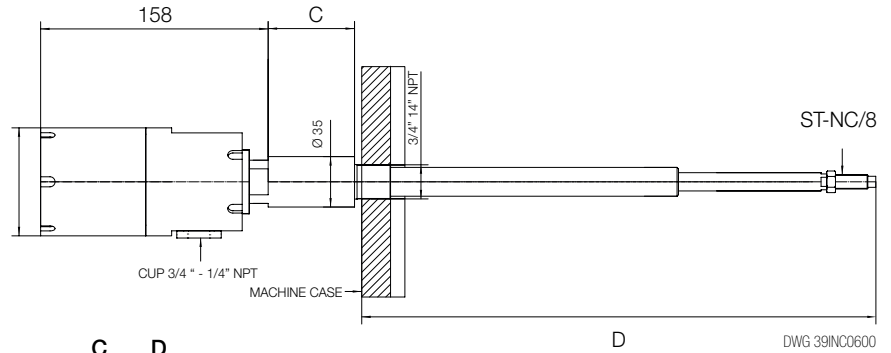

SR-6 / C / D

C: DISTANCE BETWEEN MACHINE CASING AND HOUSING PROBE ADAPTER
pitch 15 mm - minimum 0 mm - maximum 225 mm

0 0 mm (standard)

D: DISTANCE BETWEEN MACHINE CASING AND ROTOR
pitch 5 mm - minimum 100 mm - maximum 750 mm

250 250 mm (standard)

JB-1

Alu Junction Box IP65 container for TR-NC/8 transmitters.

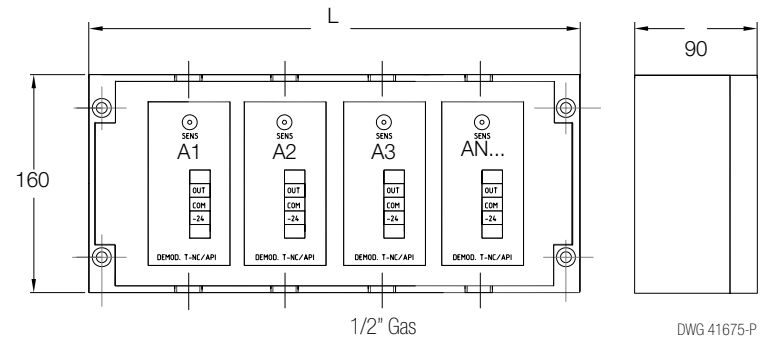

JB-1 / A

A: NUMBER OF TRANSMITTER MODULES

1 1 Module L= 160mm

2 2 Modules L= 260mm

4 4 Modules L= 360mm

6 6 Modules L= 560mm

ZENER BARRIER Z787 (FOR HAZARDOUS AREA)

PLASTIC TAG
040STR000

B5MAG10 CY002

STAINLESS STEEL TAG
980710835

B5MAG10 CY002



CEMB S.p.A. - Via Risorgimento, 9
23826 Mandello del Lario (LC) - Italy
www.cemb.com



Vibration analysis division:
Phone +39 0341 706111
e-mail: stm@cemb.com

All the data and features mentioned in this catalogue are purely for information and do not constitute any commitment on the part of our company, which reserves the right to make any and all alterations it may consider suitable without notice.